



# SUPERFLO®

## Radial Flow Chromatography

Superflo® Columns are based on unique radial flow geometry and are ideally suited for high throughput preparative and bioprocess applications. They are versatile, easy to use and offer a number of advantages over conventional columns, especially when it's time to scale-up.

Hundreds of Radial Flow Columns are used routinely in laboratories around the world in process development and clinical production. Over 20 FDA approved drugs, amongst them immunoglobulins and clotting factors from human plasma, vaccines interferons, and several recombinant drugs are manufactured on Superflo® Columns. In one instance, 20,000 liters of human plasma is processed every batch to yield ~20 Kg protein/batch.

- ✓ 5-10X Flow Rate
- ✓ Linear Scale-Up
- ✓ Small Footprint
- ✓ Easy to Use



*RFC installation processing 20,000 liters of human plasma every shift. Courtesy: Baxter*

## How it Works

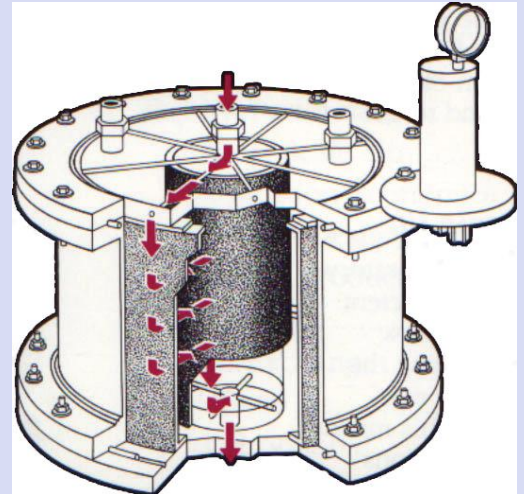

Superflo® columns are based on radial flow chromatography. The columns have three annular channels. The outer and inner channels have equal cross-sectional areas and conduct the fluid flow to the outlet. The middle channel contains the chromatographic packing. Due to the large cross-sectional area of the outer channels and the low bed depth, Superflo® columns allow extremely high flow rates with very little pressure drop.

The sample is introduced at the sample inlet from which it is distributed evenly throughout the center channel. From this outer channel, the sample flows through a porous tube and into the packing material where the sample constituents are selectively bound. After an elution procedure, the sample components pass sequentially through the inner porous tube of the column and out the column outlet.

This unique radial flow design makes the column suitable for high throughput separations such as ion exchange, affinity, hydrophobic, reverse phase and other forms of adsorption-desorption separations. The columns are, however, not recommended for bed depth dependent isocratic separations, such as size-exclusion chromatography.



## Case Study: 9X Higher Flow

- ✓ Faster Time to Market
- ✓ Smaller Footprint
- ✓ Better Economics

Superflo® Columns can dramatically reduce separation times and costs of both labor and materials. The data below was obtained from a plasma fractionation facility. The study was performed in order to compare the performance of a Superflo®-20L Column with that of a 16L axial flow column. Table 1 shows a comparison of the performance of the two columns. With the Superflo® Column, flow rates increased over 3 fold with a corresponding increase in separation speed from three shifts to one shift without affecting product recovery or purity.

Pilot Scale		
	Axial Flow Column	Superflo® Column
Flow rate:	25 L/hr	75-95 L/hr
Production rate:	350 L/3 shifts	350 L/shift
Column size:	16 L	20 L

Scale-up on radial flow columns resulted in 1/3 column size, 1/3 processing time and 1/3 media cost.

Production Scale		
	Axial Flow Column	Superflo® Column
Flow rate:	200 L/hr	200 L/hr
Production rate:	1000 L/3 shifts	1000 L/shift
Column size:	160 L	60 L
Cost of Packing	\$320,000	\$120,000
Initial Savings in Media Costs:		\$200,000

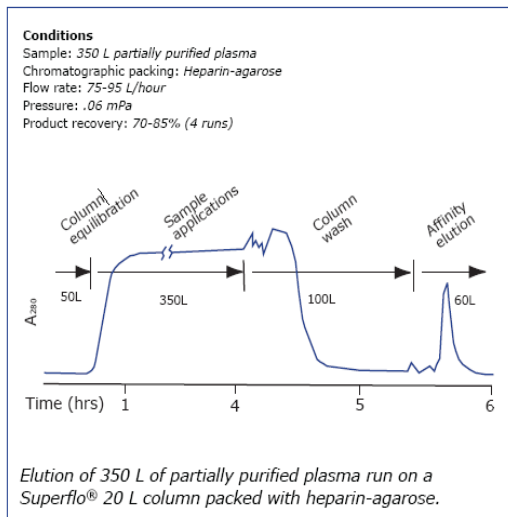

Courtesy: Bayer Corp.

## 7X Higher Flow

- ✓ Shorter Process Time
- ✓ Better Yield

### Purification of an Intracellular Bacterial Enzyme on DEAE Sephrose®

The example below shows the isolation of a recombinant protein. Not only is the processing time decreased, but the recovery is enhanced due to reduction of on column proteolytic degradation.

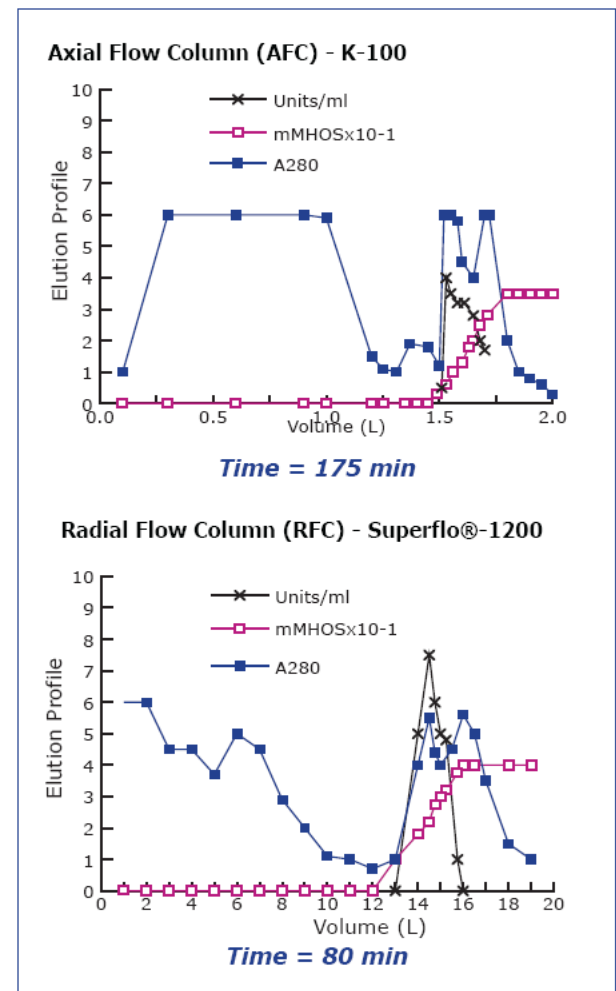

Courtesy: Genencor





## 9X Performance Advantage

- ✓ Smaller Columns
- ✓ Shorter Process Times

### Comparison of Axial and Radial Flow Chromatography – 300X Scale-Up

#### Cod Dnase Isolation on Q Sepharose® Fast Flow

Cod Dnase was isolated from fishmeal and purified using Q Sepharose Fast Flow. Lab scale studies show a 7X faster flow, which is enhanced to 9X productivity advantage upon scale-up to 100gm runs from 2500-liter preps.

#### Lab Scale Results (10mg to 300mg lots)

Column (ml)	Flow Rate (CV/hr)	Cycle Time (hr)	Purification (N-fold)	Yield (%)	Productivity (mg/hr/ml)
Axial 60ml	10	1.3	20	100	0.13
Axial 2.5L	8	1.4	13	76	0.10
Radial 250ml	70	0.25	17	107	0.70

#### Production Scale Results (100gm lots)

Column (ml)	Flow Rate (CV/hr)	Cycle Time (hr)	Purification (N-fold)	Yield (%)	Productivity (mg/hr/ml)
Axial 16L	9.5	1.6	5.2	52	3.4
Radial 5L	84	0.19	15	152	1.2

## 2000X Scale-Up

A separation developed on a copper chelating resin using conventional chromatography was scaled up 2000X with identical performance but a 50% increase in throughput.

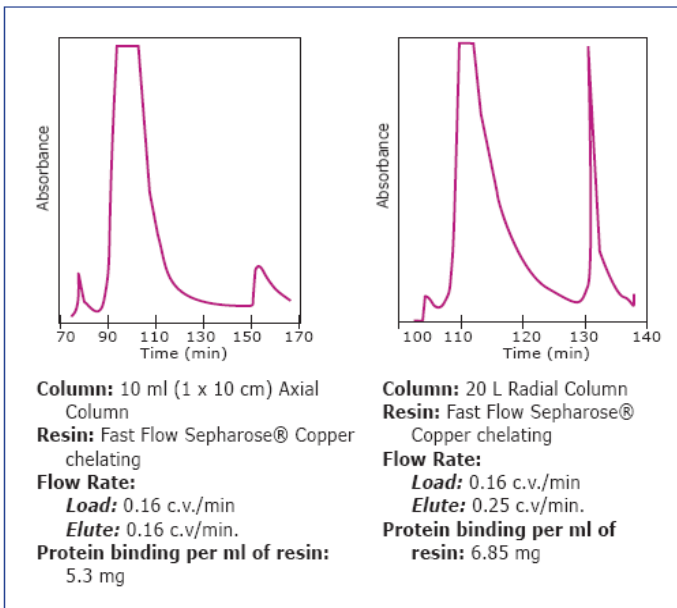

Courtesy: Chiron

## Easy Scale-Up Saves Time to

With Superflo® Columns, the sample size and flow rate can be increased linearly. When the column length is increased in proportion to the sample size, the flow rate increases linearly as well. At the same time, the pressure drop, contact time and separation time remain unchanged; because the bed depth (radius of the column) is constant.

### Pressure-Flow Curve for Process Superflo®

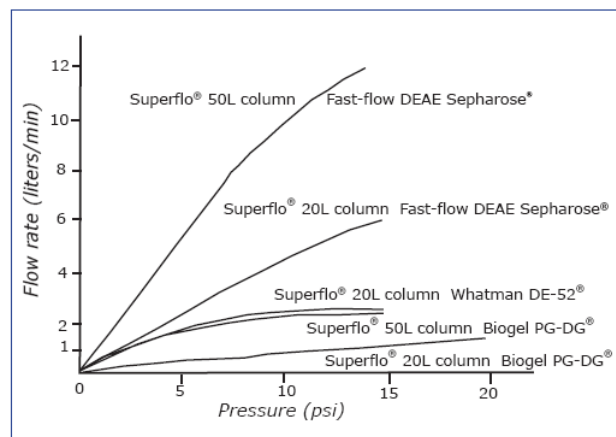



## Sanitary Design Enables GMP

Precision manufacturing and design ensure that all surfaces of Superflo® Columns are highly polished and that there are no dead legs or areas that are not flushed during cleaning cycles. Acrylic columns can be sanitized with 0.1N NaOH or with HCl. Stainless steel columns are also compatible with 20% alcohol or steam. Generally, sanitizing can be done without unpacking the column. Accessory sets with sanitary fittings are available for the pilot and process columns.

### Extractables from Superflo® Columns

Test	Blank	Sample
pH	6.00	6.20
Conductivity as ppm NaCl	0.01	0.2
mEq KMnO4/L	0.0	0.06
UV Scan	No Absorbance	No Absorbance
Non-volatile Residue as mg/L	4.4	6.4
Cell Culture Cytotoxicity	No Effect	No Effect

## Use Any Packing Material

Virtually any packing material, including soft gels, rigid media, or packings that swell and shrink can be used in Superflo® Columns. Higher flow rates at lower pressures make it possible to use inexpensive packing, even for very large-scale separations. And, packing, unpacking and sanitization can all be performed without having to take the column apart.

## Depend on Sepragen



Sepragen pioneered the development and use of radial flow columns and holds a number of patents on the basic technology. More important, the expertise available to you at Sepragen has been gained by applying this technology in laboratories and production facilities throughout the biotechnology and pharmaceutical industries. Contact us to discuss your specific application.

## Easy to Pack

The radial flow columns were the first columns to be slurry packed. The packing and unpacking process is simple and reproducible as shown below.

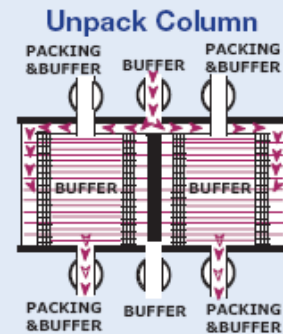
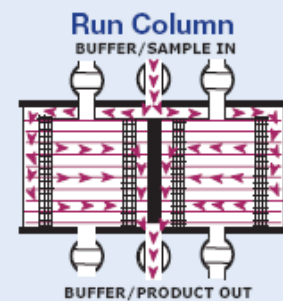
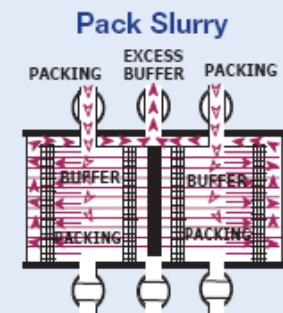
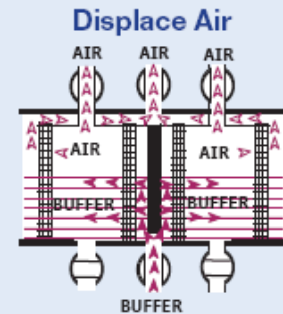

To learn more call:



(510) 475-0650

E-mail: [info@sepragen.com](mailto:info@sepragen.com)